



# USER GUIDE

**T46000 w/OBDII**  
**T46000TO without OBDII**



**1-888-621-8767**

---

# REVISION OF THE



# GUIDE

---

*Due to continuing improvements, the information contained in this user manual, the features and design of this device are subject to be changed without prior notice.*

<u>Edition/ Revision</u>	<u>Reference</u>	<u>Date</u> (week/year)	<u>Chapters updated</u>
First edition	UM-365maA-U	40/2016	-----

# TABLE OF CONTENTS

User Guide

2

<b>TECHSMART T46000</b> .....	2
1. SPECIFICATIONS .....	3
2. IMPORTANT SAFETY INSTRUCTIONS .....	4
3. CAUTION .....	5
4. TECHSMART T46000 OVERVIEW .....	6
5. FUNCTION KEYS .....	7
6. POWER ON .....	8
7. OPERATING INSTRUCTIONS .....	9
8. TPMS TIRE PRESSURE MONITORING SYTEM .....	10
9. GLOSSARY .....	11
<b>TOOL USAGE</b> .....	13
1. CHECK SENSOR.....	13
2. SERVICE TPMS.....	16
3. PROGRAM SENSOR.....	21
<b>SETTINGS</b> .....	26
1. ENTER SETTINGS MENU.....	26
<b>ABOUT</b> .....	<b>29</b>
1. ENTER THE ABOUT MENU .....	26
<b>LANGUAGE</b> .....	<b>30</b>
1. ENTER LANGUAGE MENU.....	30
2. TOOL UPDATE .....	30
<b>MISCELLANEOUS</b> .....	<b>31</b>
1. CHARGE .....	31
2. SAFETY BATTERY AND CHARGE INFORMATION.....	31
3. LIMITED HARDWARE WARRANTY .....	32
4. SERVICE ADDRESS .....	33
5. PARTS BREAKDOWN.....	34

# TECHSMART T46000 TPMS TOOL

## 1. SPECIFICATIONS

<b>Battery Type:</b>	Rechargeable Lithium-Ion
<b>Battery Life:</b>	Approximately 300 activations per full charge.
<b>Dimensions (Max. L,W,D):</b>	7.9" x 4.7" x 1.6" (20.0 cm x 12.0 cm x 4.0 cm).
<b>Case Material:</b>	High Impact ABS.
<b>Response Frequency:</b>	Main frequencies: 315 MHz and 433.92 MHz (supporting most specific frequencies).
<b>Low Battery Indication:</b>	LCD bar graph display.
<b>Weight:</b>	Approx. 2 lbs.
<b>Temperature:</b>	Operating: -4°F to 131°F (-20°C to +55°C). Storage: -40°F to 140°F (-40°C to +60°C).
<b>Operating Altitude:</b>	Up to 6560 ft (2000 m).



### Product content:

- TPMS Instrument.
- USB cable.
- Power supply.
- Soft storage case.

### Optional:

- TPMSOBD2 module w/cable

## 2. IMPORTANT SAFETY INSTRUCTIONS

**Do not discard. Retain for future reference.**

This device complies with:

- Part 15 of the FCC Rules (FCC ID: 2ABSJ-VT46)
- CE / CEM standards
- ROHS standards

Operation is subject to the following two conditions:

- (1) This device will not cause harmful interference, and
- (2) This device will accept any interference received, including interference that may cause undesired or improper operation.

**WARNING:** This product emits electromagnetic and electronically generated waves that may interfere with the safe operation of **pacemakers**.

*Individuals that have pacemakers should never use this product.*



**WARNING:**



**Do not use on live electrical circuits.**

**Please read instructions before use.**

**Wear safety goggles. (User and bystanders).**

**Risk of entanglement.**

**Read the Warranty, Safety and recycling information at the end of this user guide.**

Powered by **ATEQ**

### **3. CAUTION**

#### **PLEASE READ THESE INSTRUCTIONS BEFORE USE**

Your Tire Pressure Monitoring (TPM) tool has been designed to be durable, safe, and reliable when properly used.

All **TPMS TOOLS** are intended for use only by qualified and trained automotive technicians or in a light industrial repair shop environment. Please read all instructions below before use. Always follow these safety instructions. If you have any questions pertaining to the safe or reliable use of this tool, please call your local dealer.

#### **1. Read All Instructions**

All warnings on the tool and in this manual should be adhered to. All operating instructions should be followed.

#### **2. Retain Instructions**

The safety and operating instructions should be retained for future reference.

#### **3. Heed Warnings**

Users and bystanders must wear safety goggles and must read instructions before use. Do not use on live electrical circuits, risk of entanglement.

#### **4. Cleaning**

Clean with a soft dry cloth, or if necessary, a soft damp cloth. Do not use any harsh chemical solvents such as acetone, thinner, brake cleaner, alcohol, etc as this may damage the plastic surface.

#### **5. Water & Moisture**

Do not use this tool where contact or immersion in water is a possibility. Never spill liquid of any kind onto the tool.

#### **6. Storage**

Do not use or store the tool in an area where it is exposed to direct sunlight or excessive moisture.

#### **7. Usage**

To reduce the risk of fire, do not operate the tool in the vicinity of open containers or flammable liquids. Do not use if the potential for explosive gas or vapors exists. Keep the tool away from heat generating sources. Do not operate the tool with the battery cover removed.

## 4. TECHSMART T46000 OVERVIEW





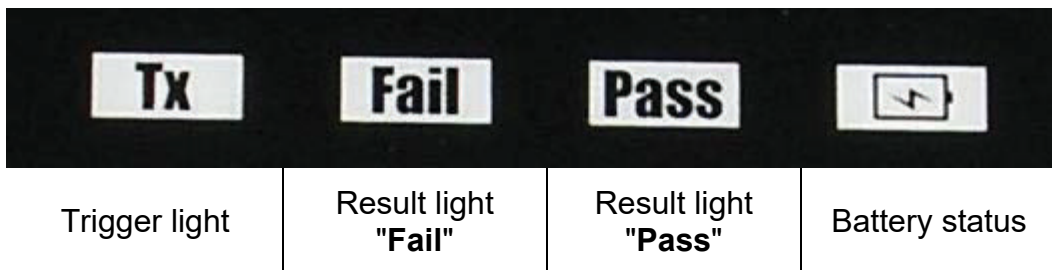



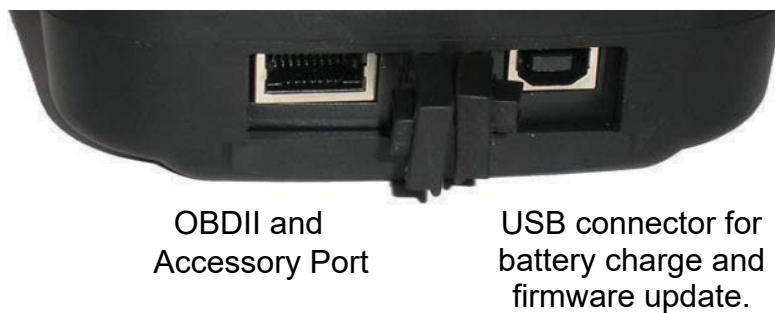

### 4.1. LIGHTS



### 4.2. CONNECTORS



## 5. FUNCTION KEYS

	Power ON/OFF switch		Test or trigger sensor.
	Next, continue or confirm.		Cancel, previous step.
	Navigate to select "up".		Navigate to select "down".
	Navigate to select "left".		Navigate to select "right".

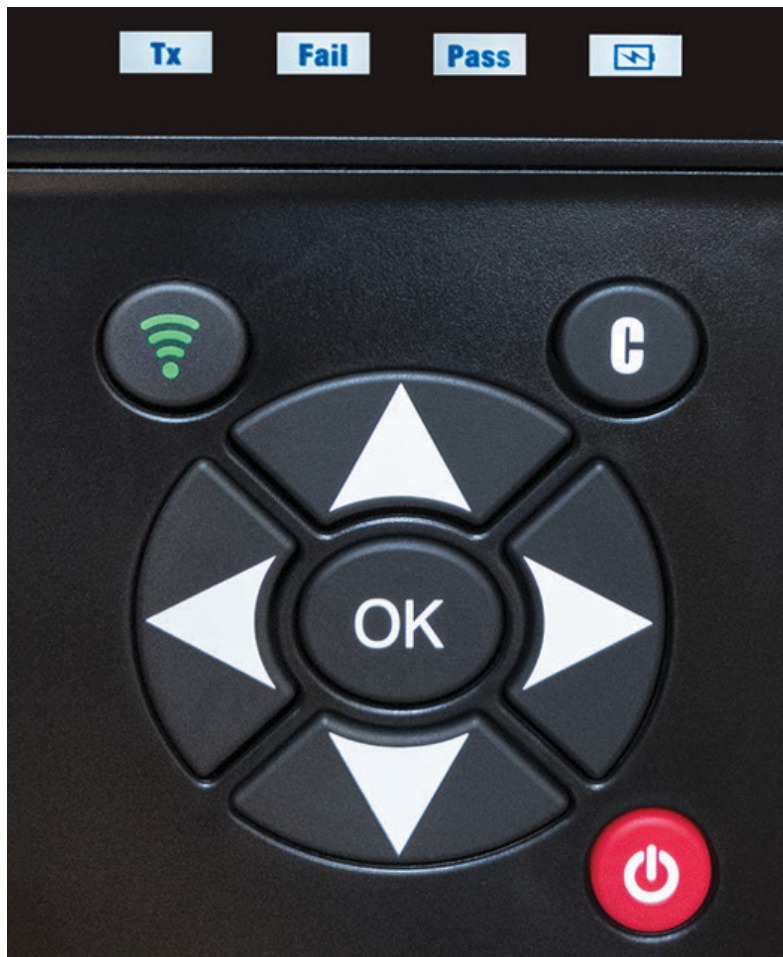



## 6. POWER ON

Press  key to turn on device, the **TPMS TOOL**



- Displays first the logo as Fig. 1.

TECHSMART AND PC SOFTWARE:  
INSTALL CD BELOW



**Fig. 1**



Connect tool to computer USB port to activate two years of software subscription

**Fig. 2**

- The **MAIN MENU** will then be displayed as Fig. 2

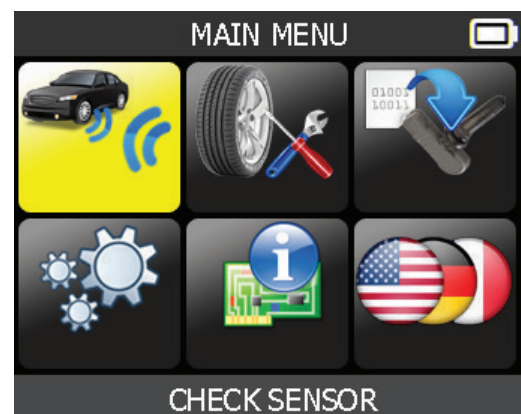

## 7. OPERATING INSTRUCTIONS

### 7.1. TPMS TOOL OVERVIEW

Read and diagnose sensors, and reset TPMS.



**Note:** With most vehicles, if the vehicle is in “learn mode” the vehicle will also confirm that the TPM sensor has communicated to the ECM with a series of horn beeps.

#### Service Procedure

##### Section 1.0: Read Sensor Test

Before servicing the tires/wheels, using your **TPMS TOOL**, trigger each of the vehicle's sensors to make sure they are working properly.

This will eliminate the liability associated with replacing previously damaged or defective sensors. This procedure will not change the vehicle settings because the vehicle has yet to be put into learn/retraining mode.

This procedure allows you to quickly identify damaged or defective sensors, because some vehicles do not report a damaged or defective sensor condition on the instrument cluster for up to 20 minutes.

**Note:** If the sensors do not trigger, please refer to the Troubleshooting section of this Guide.

Perform tire/wheel service.

For vehicles that require retraining, please see to Section 2.0

##### Section 2.0: Learning TPM System

With the vehicle in learn mode, begin by triggering the driver's front left (LF) wheel sensor. Many vehicles will provide an audible beep confirming that the sensor ID has been learned by the vehicle on board computer.

The communication between the sensor and the on board computer is also confirmed on LCD display of the **TOOL**.

The same procedure should be followed on all wheel sensors, in a clockwise rotation, until all the vehicle sensors have been retrained.

After triggering the driver's rear wheel sensor, some vehicles will beep twice, indicating that the TPM system has been retrained.

For vehicles that do not require retraining, we recommend you trigger each wheel sensor, one final time, to make sure they are working correctly prior to releasing the vehicle to the customer.

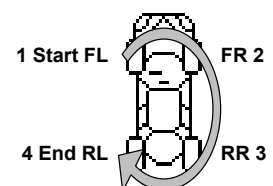
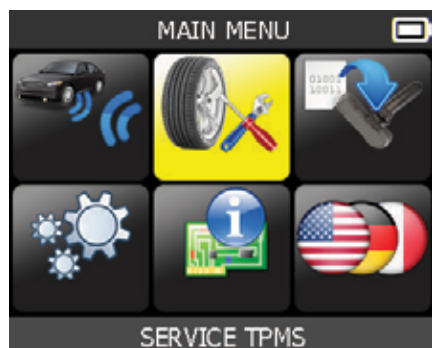
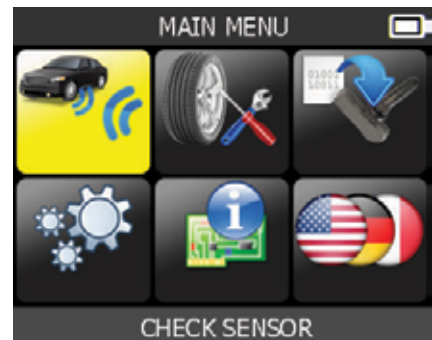
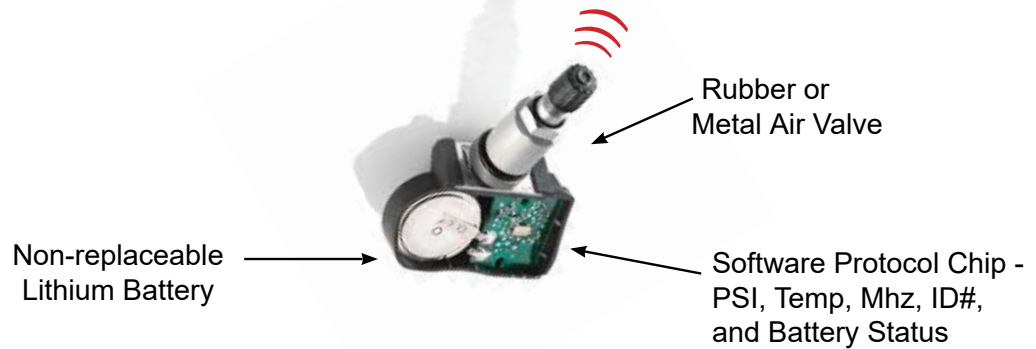
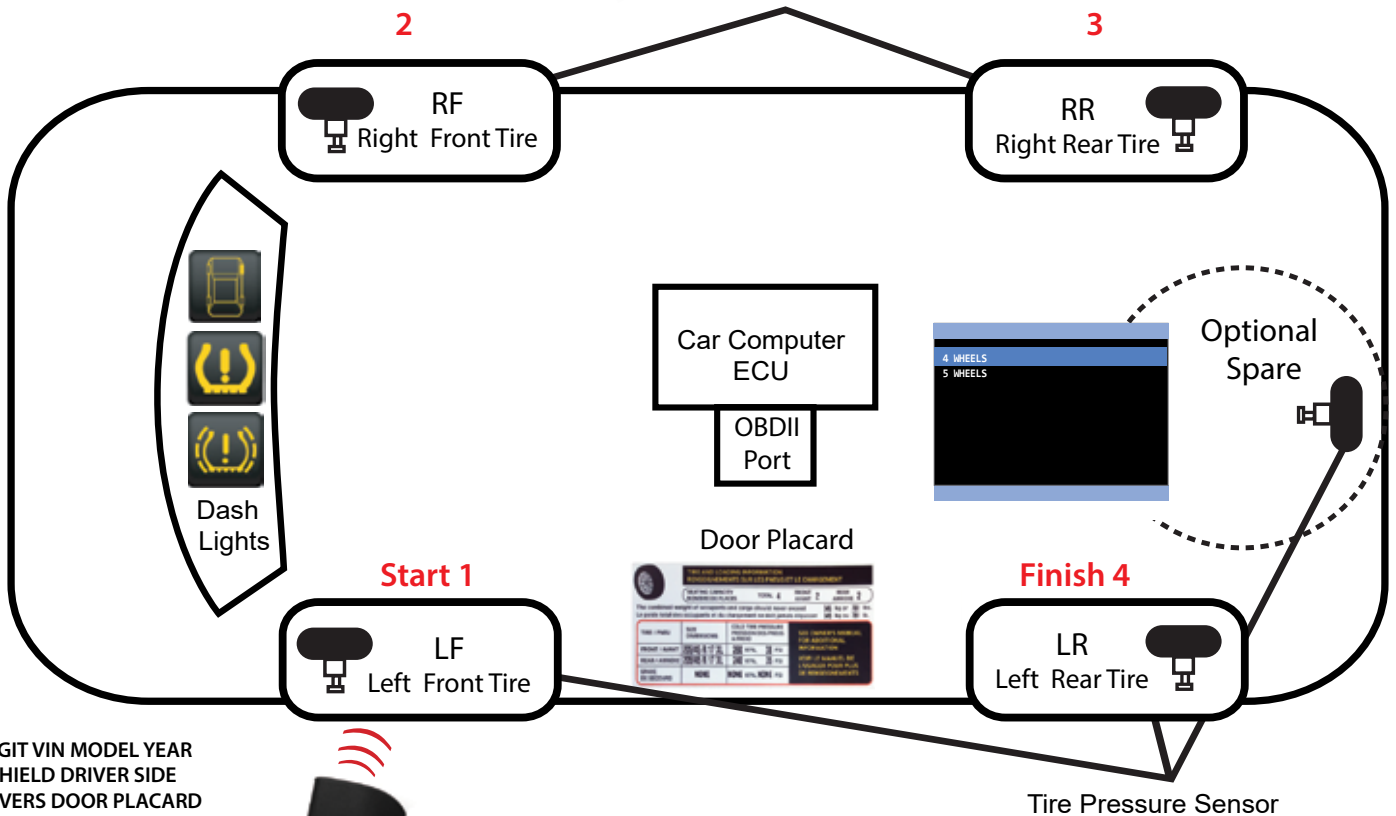

Fig. 5

# DIRECT TIRE PRESSURE MONITORING SYSTEM



Tire Pressure Sensor Components



10<sup>TH</sup> DIGIT VIN MODEL YEAR  
WINDSHIELD DRIVER SIDE  
OR DRIVERS DOOR PLACARD

- 2002 2
- 2003 3
- 2004 4
- 2005 5
- 2006 6
- 2007 7
- 2008 8
- 2009 9
- 2010 A
- 2011 B
- 2012 C
- 2013 D
- 2014 E
- 2015 F
- 2016 G
- 2017 H



## TIRE PRESSURE MONITORING TECHNICIAN GLOSSARY

1. **ACTIVATE**-A LOW FREQUENCY (LF) WIRELESS SIGNAL IS SENT THROUGH TOOL ANTENNA TO THE SENSOR INSIDE THE TIRE. THIS ALLOWS TECHNICIAN TO READ TIRE PRESSURE, ID NUMBER, TEMP AND BATTERY STATUS WITHOUT DRIVING THE VEHICLE.
2. **AFTERMARKET SENSOR**-REPLACEMENT SENSORS SUPPLIED BY LOCAL AUTO PARTS STORES OR TIRE SUPPLIERS. THE SENSOR MAY NOT PHYSICALLY LOOK LIKE THE OE SENSOR.  
YOUR TOOL HAS SPECIAL PROGRAMMING SOFTWARE BASED ON THE SPECIFIC SENSOR BRAND.
3. **AUTO RELEARN**-SENSOR ID NUMBERS ARE SENT TO THE ECU AFTER DRIVING THE VEHICLE FOR A SPECIFIED TIME. YOUR TOOL WILL INDICATE THE REQUIRED DRIVING TIME UNDER SERVICE TPMS ICON.
4. **BATTERY LIFE**-SENSORS HAVE AN INTERNAL LITHIUM ION BATTERY WHICH CAN NOT BE REPLACED. TYPICAL LIFE IS SOMEWHERE BETWEEN 5-10 YEARS. YOUR TOOL WILL DISPLAY NO SENSOR DETECTED ON THE SCREEN IF SENSOR BATTERY HAS FAILED. A DTC CAN BE SET IN THE ECU ALSO.
5. **CLONEABLE OR CLONING**-USED ONLY BY AFTERMARKET SENSOR BRANDS TO COPY THE ID NUMBER AND COMMONLY SKIP THE RELEARN PROCEDURE. NOT RECOMMENDED BY OE VEHICLE MANUFACTURER. ALWAYS RELEARN THE TPM SYSTEM WHEN CHANGING A SENSOR.
6. **CROSS TALK**-WHEN THE TPMS TOOL SIGNAL GETS CONFUSED BY ANOTHER SENSOR SIGNAL. EXAMPLE: YOU HAVE REPLACE AN OLD SENSOR BUT IT IS IN CLOSE PROXIMITY DURING YOUR RELEARN THE NEW SENSOR. THE OLD SENSOR SHOULD BE REMOVED FROM THE SERVICE BAY AS IT MAYBE TRANSMITTING
7. **DELTA PRESSURE**-A RAPID CHANGE IN TIRE PRESSURE UP OR DOWN AS AN ALTERNATIVE METHOD TO LF WHICH ACTIVATES THE SENSOR. REFER TO SERVICE MANUAL AS WELL AS TOOL ON SCREEN INSTRUCTIONS. COMMON ON GM PRIOR TO 2009 AND MANY EUROPEAN SYSTEMS.
8. **DIAGNOSTIC TROUBLE CODE(DTC)**-SIMILAR TO CHECK ENGINE LIGHT BUT CODES ARE SPECIFIC TO TPMS
9. **DIRECT SYSTEM**-MOST COMMON DESIGN USED BY MAJORITY OE'S. 4 TO 6 TPM SENSORS WITH VALVES MOUNTED INSIDE THE TIRE. VALVES MAYBE RUBBER OR METAL DESIGN AND IT IS IMPORTANT TO SERVICE THE REPLACEABLE PARTS. BE CAREFUL SOME VEHICLE MAY USE DIRECT AND INDIRECT DEPENDING ON THE MODEL. YOUR TOOL SCREEN WILL SHOW INDIRECT UNDER SERVICE ICON EVEN THOUGH NO PHYSICAL TPM SENSOR INSIDE THE TIRE.
10. **HIGH LINE**-THE VEHICLE DASH WILL DISPLAY TIRE PRESSURE BY WHEEL LOCATION. ALSO CALL ADVANCED SYSTEM. MANY LUXURY VEHICLES SHOW PRESSURE AND TEMPERATURE. SOME VEHICLE MANUFACTURERS OFF UPGRADE ACCESSORY OPTIONS INCLUDING HIGH LINE. EXAMPLE: 2015/2016 TOYOTA CAMRY IS STANDARD WITH LO LINE BUT OPTIONAL COLORED DASH DISPLAY WILL BE A HI LINE. SELECT CORRECT SYSTEM WHEN ORDERING REPLACEMENT SENSOR PART NUMBER.
11. **HYBRID SENSOR**-A TYPE OF PROGRAMMABLE AFTERMARKET SENSORS. THE TECHNICIAN SELECTS MAKE/MODEL AND YEAR AND TRIGGERS ACTIVATION WITH THE TPMS TOOL IN 1-3 SECONDS. EXAMPLE: HAMATON U-Pro
12. **ID NUMBER**-A SPECIFIC DECIMAL OR HEXADECIMAL NUMERIC NUMBER ASSIGNED TO EACH SENSOR. THIS ALLOWS ECU TO SEE SPECIFIC TIRE LOCATION BY EACH SENSOR FOR RESETTING OR RELEARNING THE TPM SYSTEM. IN MANY CASES PHYSICALLY PRINTED ON SENSOR BODY BUT NO EASY TO READ. YOUR TOOL WILL DISPLAY THE SENSOR ID NUMBER.
13. **INDIRECT SYSTEM**-THIS DESIGN DOES NOT HAVE A PHYSICAL SENSOR W/VALVE INSIDE THE TIRE. INSTEAD IT CALCULATES LOW PRESSURE FROM THE (ABS) ANTI-LOCK BRAKE SYSTEM WHEEL SPEED SENSOR. RESET INSTRUCTIONS ARE IN YOUR TOOL WHEN ADJUSTING AIR PRESSURE. HOWEVER, A FULL FUNCTION DIAGNOSTIC SCAN TOOL WITH GRAPHING IS REQUIRED TO DIAGNOSE ABS WHEEL SPEED SENSORS.
14. **LEARN MODE**-THE VEHICLE'S RECEIVER AND ECU ARE ACTIVATED TO PICK UP THE WIRELESS SIGNAL BEING TRANSMITTED FROM THE SENSOR INSIDE THE TIRE (DIRECT SYSTEM) YOUR TPMS TOOL WILL SHOW VARIOUS INSTRUCTIONS SUCH AS USING A KEY FOB, CYCLING IGNITION SWITCH, PRESSING BRAKE PEDAL, ETC. DEPENDING ON VEHICLE MAKE/MODEL AND YEAR. SPARE TIRE MAY HAVE A FUNCTIONING SENSOR AND CAN BE INCLUDED IN LEARN MODE.
15. **LOW LINE-SYSTEM** DO NOT SHOW PRESSURE BY WHEEL LOCATION JUST A SYMBOL INDICATING LOW PRESSURE ON ONE OF THE TIRES. LOW LINE SENSORS SHOULD NOT BE USED ON HIGH SYSTEMS. EXAMPLE: HYUNDIA GENESIS COUPES ARE LO LINE BUT GENESIS SEDANS ARE HI LINE.

## **TIRE PRESSURE MONITORING TECHNICIAN GLOSSARY**

16. **MALFUNCTION INDICATOR LAMP (MIL)**- A LIGHT THAT ILLUMINATES ON THE VEHICLE'S DASH WHEN THE TPM SYSTEM IS SEEING AN ISSUE. SOLID LIGHT INDICATES PRESSURE LOWER THAN THE OE VEHICLE MANUFACTURER RECOMMENDS. A RELEARN OR RESET IS REQUIRED TO TURN THE LIGHT OFF. FLASHING LIGHT INDICATE COMPONENT ISSUES.
17. **MULTI-APPLICATION SENSOR**-AFTERMARKET SENSORS THAT ARE PRE-PROGRAMMED WITH A VARIETY OF MANUFACTURER PROTOCOLS ON THE SENSOR CHIP. FOLLOW OE MAKE,MODEL AND YEAR RE LEARN PROCEDURES WHEN INSTALLING THESE SENSORS.
18. **OBDII TPMS**- USING A STAND ALONE TPMS TOOL OR DIAGNOSTIC SCAN TOOL CAPTURE ID NUMBERS TO TRANSMIT TO THE VEHICLE ECU VIA THE OBDII PORT. COMMON ON JAPANESE AND KOREAN MODELS. CAN BE USED ON SELECT DOMESTIC VEHICLES TO ALSO PUT VEHICLE INTO LEARN MODE.
19. **OE SENSORS**-PRE-PROGRAMMED WITH SINGLE SOFTWARE PROTOCOL.
20. **PLACARD**-A DECAL ON INSIDE OF THE VEHICLE DRIVERS DOOR WITH RECOMMENDED AIR PRESSURE AND TIRE SIZE. REQUIRED BY TREAD ACT FOR ALL MANUFACTURERS
21. **PROGRAMMABLE SENSOR**-A BLANK TPM SENSOR SUPPLIED BY AFTERMARKET PARTS COMPANIES. BRAND NAME EXAMPLES: EZ SENSOR, QWIK SENSOR, SENS IT, UPRO, ETC. TECHNICIAN MUST PROGRAM THE CORRECT MAKE/MODEL/YEAR SOFTWARE PROTOCOL FROM THE TPMS TOOL. CREATE ID OR COPY ID INSTRUCTIONS WILL BE SHOWN ON THE TOOL.
22. **PROTOCOL**-THE SPECIFIC OE SOFTWARE INSIDE THE SENSOR CHIP THAT IS REQUIRED TO MATCH THE MANUFACTURER MAKE/MODEL AND YEAR.
23. **RADIO FREQUENCY (RF)**-THE RADIO WAVE SPECIFIED BY FCC FOR CAR MANUFACTURERS TIRE PRESSURE MONITORING SYSTEMS IN NORTH AMERICA. SERVICE AND PARTS CATALOGS WILL INDICATE 314.9,315, 433.92, OR 434 MHZ. THESE NUMBERS CAN ALSO BE PRINTED ON SENSOR BODY. YOUR TPMS TOOL WILL ALSO SHOW FREQUENCY MHZ.
24. **ROLLING MODE**-SENSORS GENERALLY SAMPLES DATA EVERY 60 SECONDS WHEN VEHICLE IS IN MOTION AND MAINTAINS A MINIMUM SPEED.
25. **SERVICE KITS**-TPMS VALVE COMPONENTS SUCH AS GASKETS, GROMMETS, SEALS, VALVE CORES, SCREWS AND CAPS NEED TO BE SERVICED DURING TIRE CHANGES. REMEMBER THE VALVE IS IMPORTANT TO ENSURING TIRE PRESSURE IS MAINTAINED FOR SAFETY AND FUEL ECONOMY.
26. **SLEEP MODE**-SENSOR BATTERIES LIFE IS CONSERVED DURING PERIODS OF TIME VEHICLES ARE NOT BEING USED. EXAMPLE: SHIPMENT TO THE NEW CAR DEALER. THIS MAY VARY BY MANUFACTURER AND ANOTHER TERM IS STORAGE MODE.
27. **STATIONARY RELEARN** MODE-A TERM USED WHEN THE VEHICLE IS NOT BEING DRIVEN. EXAMPLE: A VEHICLE IS IN YOUR SERVICE BAY OVERNIGHT. THE TRANSMISSION OF SENSOR INFORMATION HAS BEEN REDUCED TO SAY BATTERY LIFE. NOT EVERY OE USES THE SAME METHOD.
28. **TREAD ACT**-THE US FEDERAL LAW THAT MANDATED ALL VEHICLES UNDER 10,000 LBS HAVE A TPMS SYSTEM AFTER 2007. MANY VEHICLES BEFORE 2007 HAVE TPMS.
29. **TRIGGER TOOL**-A GENERIC TERM USED FOR ANY HAND HELD TOOL WITH OR WITHOUT A DISPLAY TO ACTIVATE A DIRECT TPM SENSOR BY (LF) LOW FREQUENCY WIRELESS SIGNAL. ALSO CALLED ACTIVATION OR EXICTER TOOL.
30. **UNIVERSAL SENSOR**-AN AFTERMARKET PARTS TERM USED TO DESCRIBE A SENSOR THAT CAN WORK ON MORE THAN A SINGLE MAKE/MODEL AND YEAR.
31. **VEHICLE PROGRAMMING**-SOMETIMES USED IN PLACE OF TERM RELEARN OR RESET THE LIGHT
32. **VEHICLE RELEARNING**-THE STEPS SHOWN ON THE TPMS TOOL FOR THE TECHNICIAN TO FOLLOW WHEN AD JUSTING TIRE PRESSURE, ROTATING TIRES OR REPLACING A TPM SENSOR. THEY FALL INTO THREE TYPES-AUTO RELEARN, STATIONARY OR OBDII
33. **WIRELESS AUTO LOCATE (WAL)** SYSTEMS SHOW PRESSURE BY TIRE LOCATION. AFTERMARKET SENSOR SUPPLIERS OFTEN LIST A SECOND PART NUMBER TO COVER WAL APPLICATIONS. WAL USED ON - CHRYSLERS, JEEPS AND MERCEDES VEHICLES WHERE SCHRADER IS OE SUPPLIER. USING INCORRECT PART NUMBER CAN RESULT IN TPMS DASH LIGHT TURNING ON EVEN WHEN TIRE PRESSURE IS CORRECT.

FOR ADDITIONAL ON LINE TPMS TECHNICIAN TRAINING COURSES PLEASE GO TO **[WWW.TIREINDUSTRY.ORG](http://WWW.TIREINDUSTRY.ORG)**

# TECHSMART

## IMPORTANT:

Vehicle specific information in this manual is used as an example and may not represent specific instructions each make and model may require. When performing various functions with the tool, it is important to refer to the on-screen prompts and/or repair manual information.

### 1. CHECK SENSOR

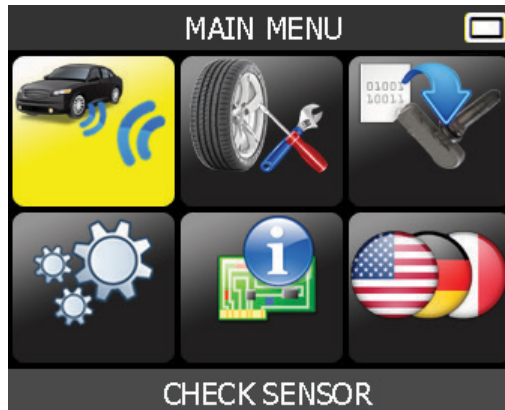

= continue



= Previous

#### 1.1. SELECT CAR MANUFACTURER

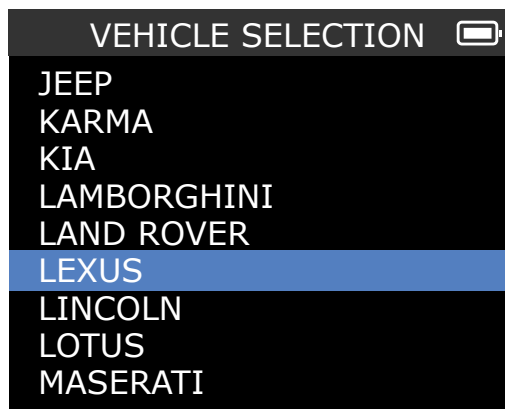

= continue



= Previous

#### 1.2. SELECT CAR MODEL

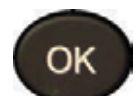
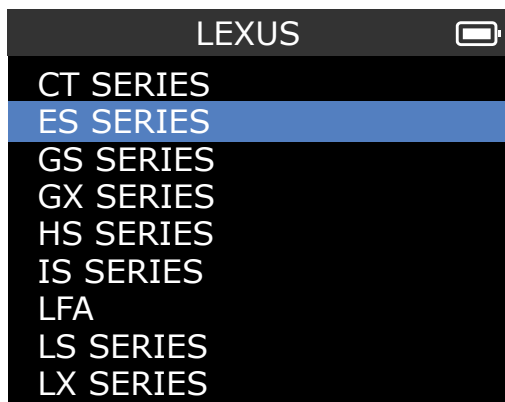

= continue



= Previous

# Check Sensor

## 1.3. SELECT YEAR

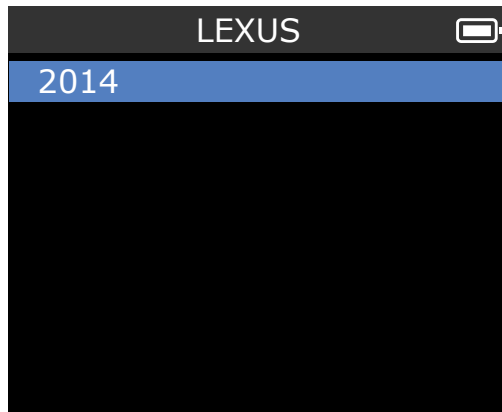

= continue



= Previous

## 1.4. SELECT WHEEL NUMBER

This option does not appear for all vehicles.

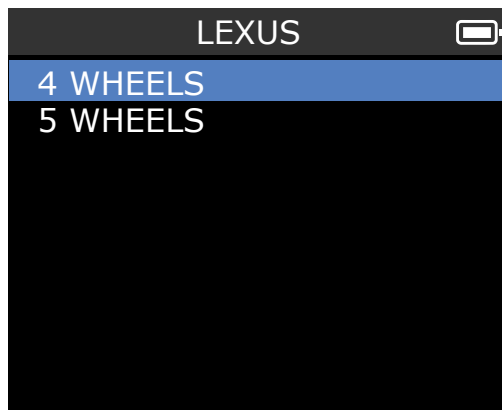

= continue



= Previous

## 1.5. TEST SENSORS (TRIGGER)



Select tire.

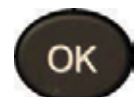
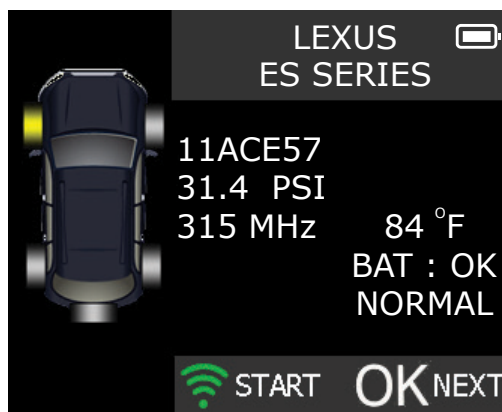

= continue



= Previous

## 1.6. CHECK SENSOR

To change tire



The tool is triggering the sensor.

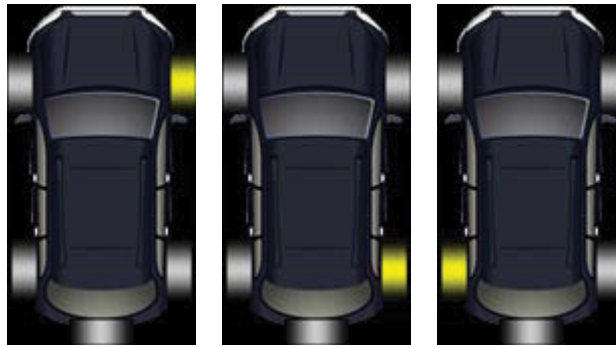

Pass

Pass

Pass

Trigger all wheels.

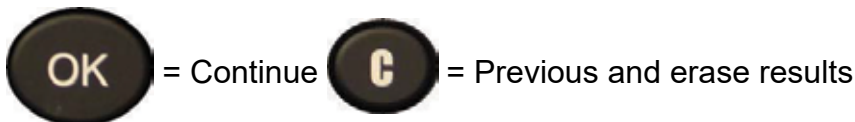

Fail

The tool does not detect a sensor

### Possible Reasons

1. Tool Antenna is not positioned correctly on tire
2. Sensor battery has expired
3. Wrong sensor part number was installed
4. Technician has removed sensor from the tire
5. Aftermarket sensor was not programmed with tool
6. Indirect system works off ABS wheel sensor speed

## 2. SERVICE TPMS

Servicing TPM System to ensure the dash light is not illuminated maybe required when adding air, rotating tires, or replacing a sensor.

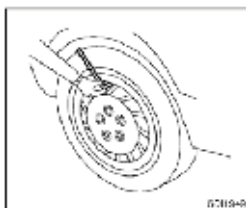

Servicing may require the use of the TPMS trigger tool and a device to access the OBDII Port. Two methods are shown-1. TPMS tool w/optional OBDII Module or TPMS tool with an existing diagnostic scan tool.



## 2.1 SERVICE TPMS-P/N LOOK-UP

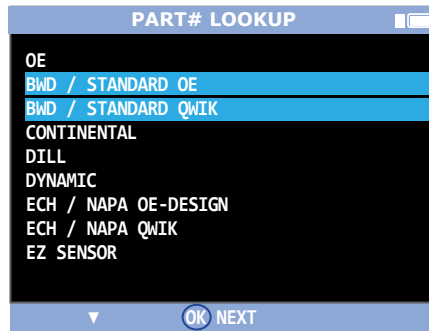

This section details how to relearn the sensor to the ECU.



Select "**SERVICE TPMS**" menu.

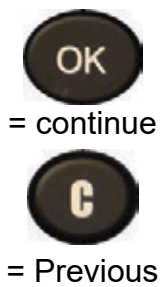
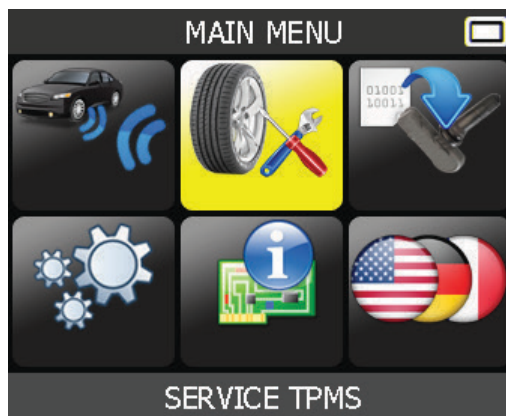

- Select car manufacturer.
- Select car model.
- Select year.

## 2.2 AUTO RELEARN SYSTEMS

(Acura, Select Hondas, Jaguar, Land Rover, Volvo, Chrysler, Dodge and Jeep Brands)

Check tire pressure with TPMS Tool VS door placard and drive the vehicle.

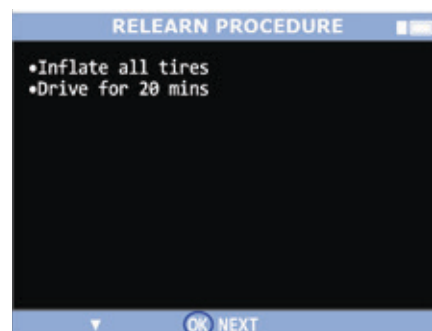
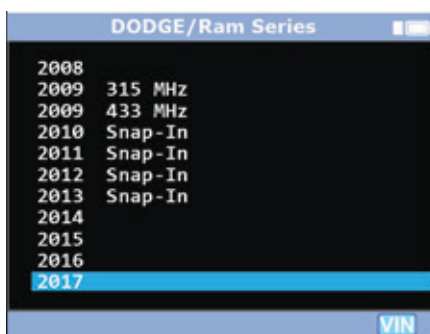

## 2.3 SERVICE TPMS

### MANUAL OR STATIONARY RELEARN SYSTEMS

(General Motors, Ford, BMW, ,Mini, and Porsche)

Use Tool and follow instructions on the screen.

**1**

**CHEVROLET/CAMERO**

2010  
2011  
2012 Clamp-In  
2012 Snap-In  
2013 Clamp-In  
2013 Snap-In  
2014 Clamp-In  
2014 Snap-In  
2015 Clamp-In  
2015 Snap-In  
**2016**

VIN

**2**

**RELEARN PROCEDURE**

- Inflate all tires
- Apply parking brake
- Turn Ignition ON
- Push the MENU button to select Vehicle Information in DIC
- Use arrow keys to select Tire Pressure
- Push SET/CLR button to start Sensor matching
- Push SET/CLR button to select YES
- Horn chirps 2x DIC displays TIRE
- LEARNING ACTIVE

▼ OK NEXT

**3**

**CAMERO**

- Push SET/CLR button to start sensor matching
- Push SET/CLR button to select YES
- Horn chirps 2x DIC displays TIRE LEARNING ACTIVE
- Use tool to activate LF

▼ / ▲ C stop OK NEXT

**4**

**CAMERO**

sensor

- Single horn sounds
- Repeat for RF/RR/LR
- Horn chirps 2x for relearn complete

▼ / ▲ C stop OK NEXT

## 2.4 SERVICE TPMS (W/OBDII Module P/N TPMSOBD2)

### OBDII RELEARN

1

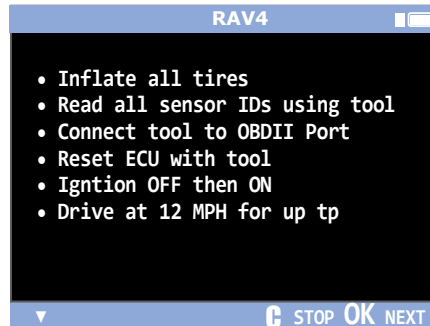

1. Start left front wheel and trigger sensor

→ **11ACE57**  
31.4 PSI  
315 MHz



2. Next right front wheel and trigger the sensor

→ **11AC923**  
31.1 PSI  
315 MHz



3. Next right rear wheel and trigger the sensor

→ **11AD0FA**  
30.4 PSI  
315 MHz



4. Next left rear wheel and trigger the sensor

→ **F198d**  
37.6 PSI  
315 MHz



5. OBDII

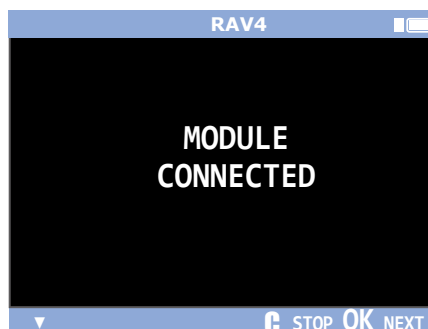

6. 5th Wheel option depending on make/model/year Examples-Toyota RAV 4, Tundra, Land Rover, and many Jeeps. Visual inspect spare, test sensor with TPMS tool, or reference VIN number with new car dealer See pg 10) Relearn will fail if spare ID number is not registered and a DTC code can be set.

## SERVICE TPMS (Scan Tools Options)

5. Follow instructions for registering sensor Id on scan tool.

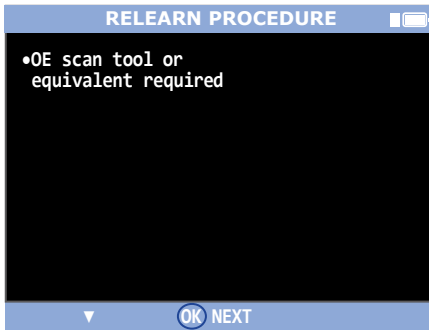

Select your scan tool

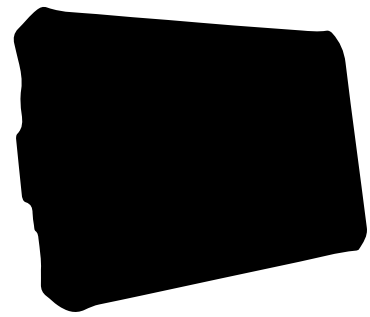

6. Select brand make and year  
Lexus ES 350 is example shown

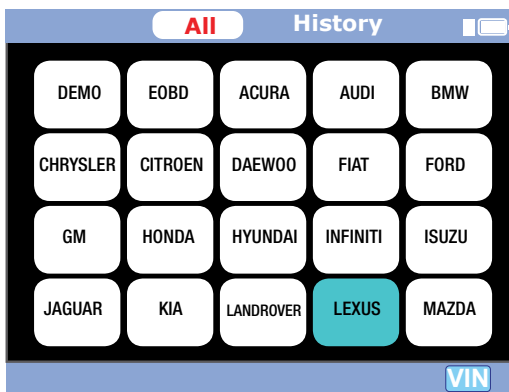

7. Connect scan tool OBDII connector to the vehicle.



8. Select system selection, chassis

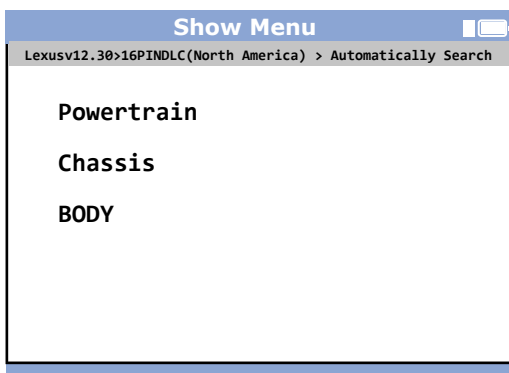

**Note: Some TPMS Selection maybe in Body**

## SERVICE TPMS

### 10. Select TPMS

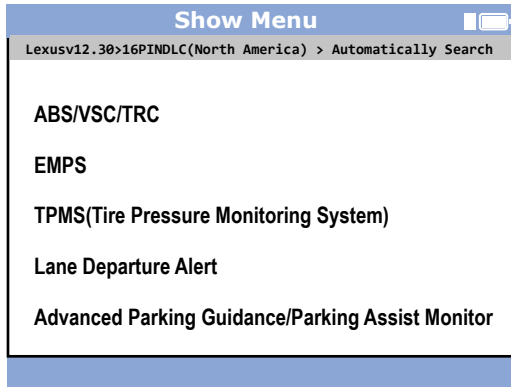

### 11. Select ID Registration

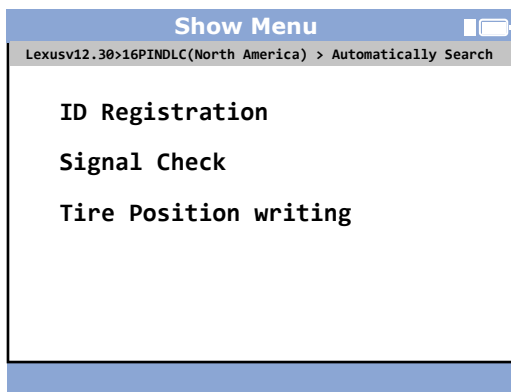

### 12. ID Registration Procedure

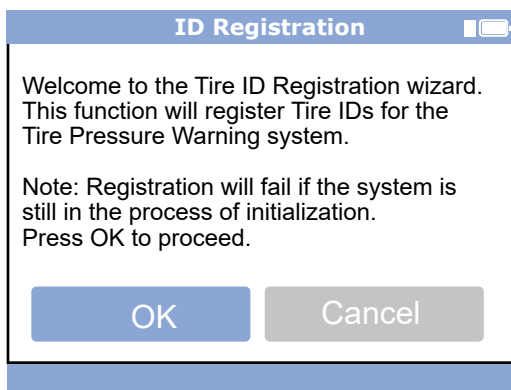

### 13. Enter ID# on scan tool from steps 1-5

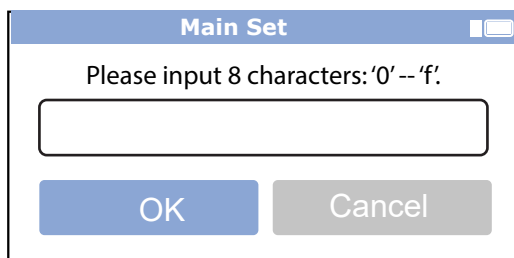

**LF 11ACE57**  
**RF 11AC923**  
**RR 11AD0FA**  
**LR F198d**

# PROGRAMMABLE AND OE REPLACEMENT SENSORS

1.

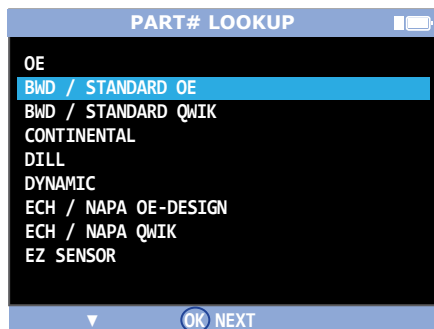

2.

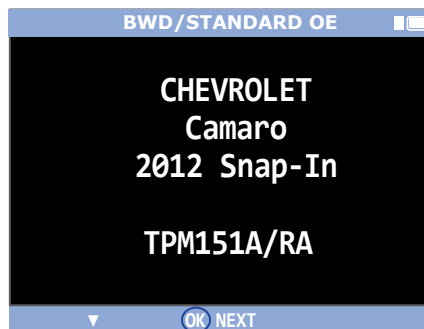

*\*Part numbers without an A PREFIX installation will require following the manual or OBDII OE relearn instructions. P/N's with A prefix can have Sensor ID copied under Programmable function. See SMP bulletin #ST10253IDL –TPMS Sensor ID Number Locator on [www.techsmartparts.com](http://www.techsmartparts.com)*

1.

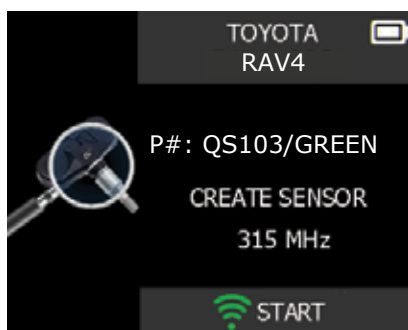

2.

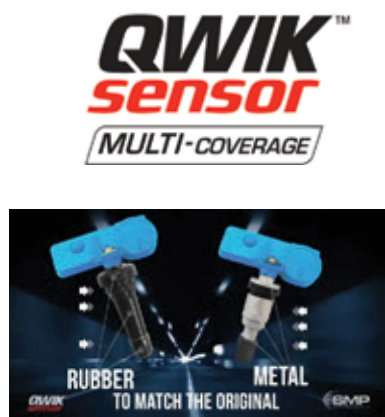

3.



Rubber or Metal Valve Stems

1. **Always program sensor with the tool before installing in the tire**
2. **Three sensor Installation Options**
  - A. Copy ID from existing working OE sensor. Install in same tire position.
  - B. Create a brand new ID with the tool and perform OE relearn
  - C. Manual enter ID number on tool keypad from non working OE sensor body (see SMP bulletin #ST10253IDL) Relearn optional if installed in same tire position.

**WWW.TECHSMARTPARTS.COM**

### 3. PROGRAM SENSOR

This section is to recover a sensor ID in order to enter it in the spare blank sensor. If the "old" sensor can be read, use the **"COPY ORIGINAL SENSOR"** section to recover the ID. If it cannot be read, use the **"CREATE NEW SENSOR"** section to create a randomized ID.

This section details how to relearn the sensor to the ECU with the OBD-II port or to have the part # lookup for all the sensors available for the vehicle.



Select **"PROGRAM SENSOR"** menu.

- Select car manufacturer.
- Select car model.
- Select year.

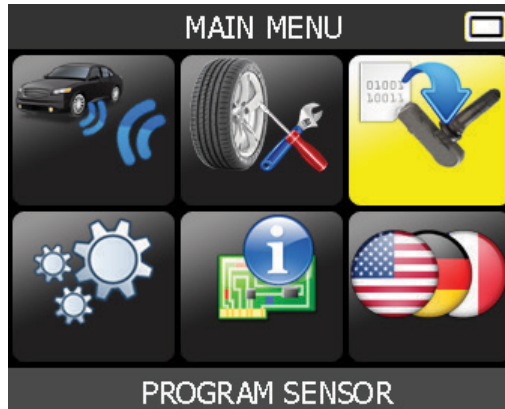

= continue



= Previous

3.1



Select the sensor's brand.

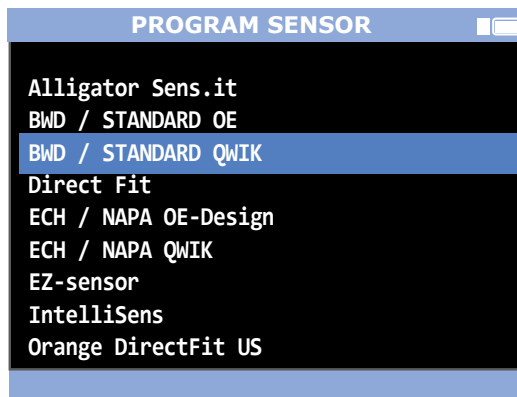

= continue



= Previous

The device displays blank sensor's reference of the selected dealer.

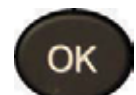
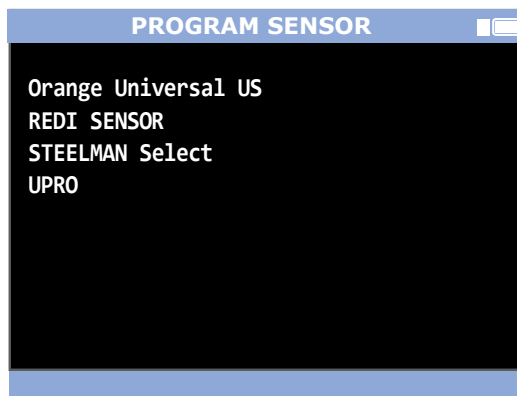

= continue



= Previous

**Note:** You may have to choose a generation of sensors, here is an example.

### 3.2. "COPY ORIGINAL SENSOR" SECTION



BWD/STANDARD QWIK

COPY ID  
CREATE SENSOR

---

TOYOTA   
RAV 4

COPY ID

START

---

TOYOTA   
RAV 4

TRIGGER PROCESSING

START

---

TOYOTA   
RAV 4

F9199D  
40.4 PSI  
315 MHz      78 °F  
BAT : OK  
NORMAL

START    OK NEXT



Wait a few seconds.

ID of the old sensor is displayed.

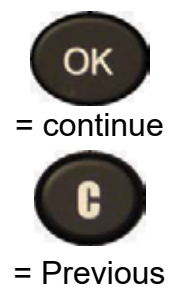



Hold the new programmable sensor near the device antenna.

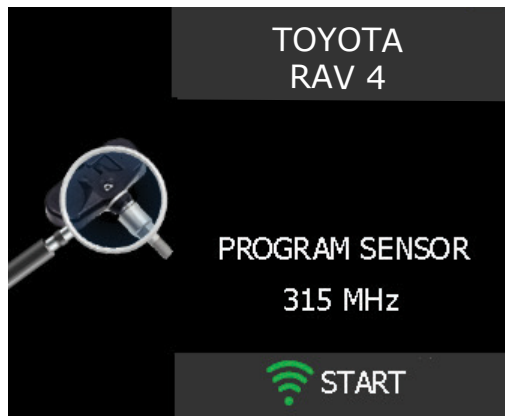

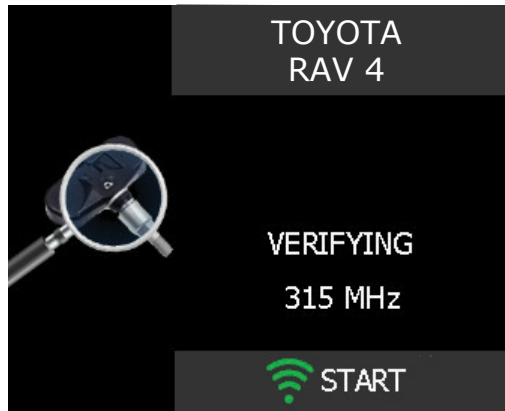

  
To upload data to the blank sensor.

Wait a few seconds.

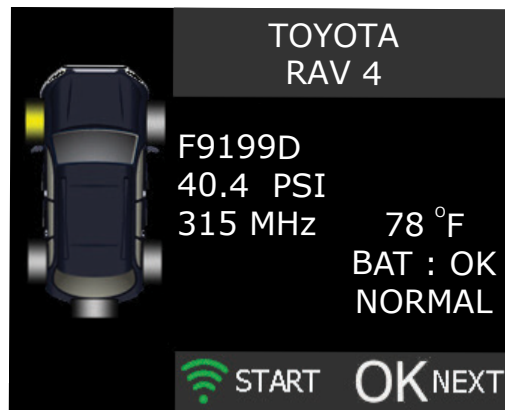

The data is successfully uploaded to the sensor.



  
= continue

Example of Sensor ID # on body

ID# F9199D



**Pacific Style Sensor**

Acura, Honda, Infiniti,  
Lexus, Nissan, Pontiac,  
Scion, Toyota

### 3.3. "CREATE NEW SENSOR" SECTION



Hold the new programmable sensor near the device antenna.

Wait a few seconds.

The data is successfully uploaded to the sensor.

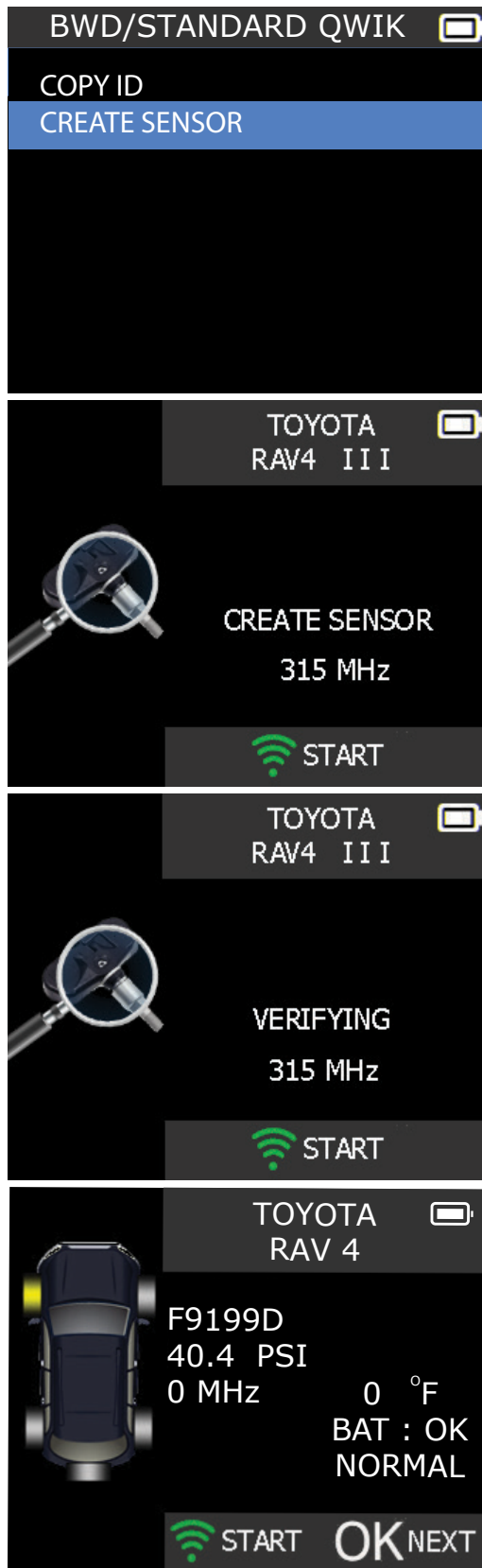

= continue



= Previous



To upload data to the blank sensor.



= continue

# SETTINGS

## 1. ENTER SETTINGS MENU



Select "**SETTINGS**" menu.



Scroll up and down to select function or settings.

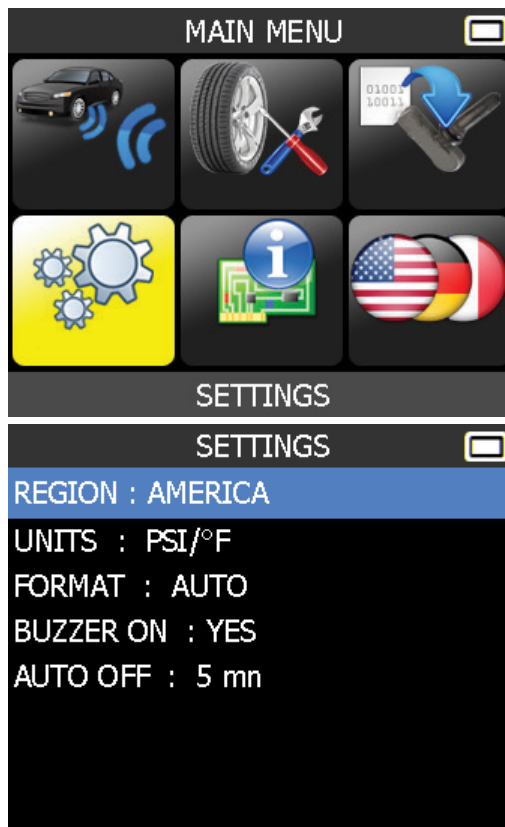

= continue



= Previous



= continue



= Previous

### Key functional descriptions:

**REGION:** to select the area of work, **AMERICA** or **EUROPE**. Be careful, when you change the zone, a WebVT download or SD card is required to get the zone data.

**UNITS:** change the air pressure and temperature display (kPa, Bar or PSI with F° or C°).

**FORMAT:** change the format of sensor ID display.

**BUZZER:** turn buzzer to ON or OFF (YES or NO).

**AUTO OFF:** time to turn off the device automatically after not being operated.

### 1.1. CHANGE REGION SETTINGS



Scroll up and down to select the zone menu.

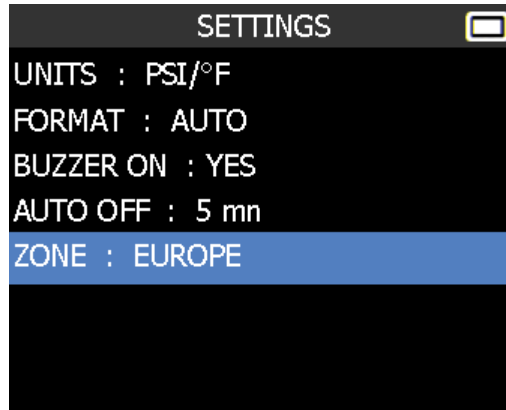

= Confirm



= Previous



Scroll up and down to select a zone.



= Confirm



= Previous

The tool will load the new database for the selected zone.

### 1.2. CHANGE UNITS SETTINGS



Scroll up and down to select function or settings.

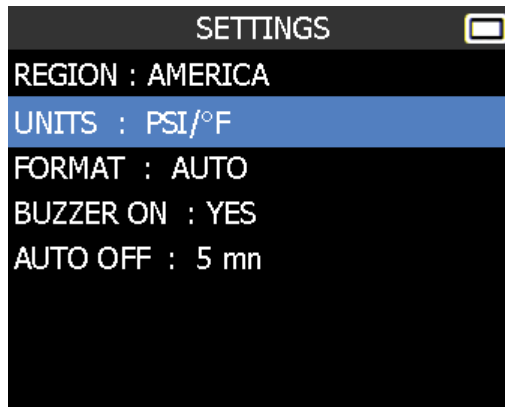

= continue



= Previous



Scroll up and down to select the units.

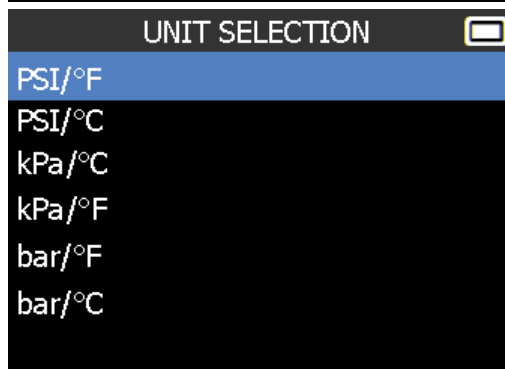

= continue



= Previous

### 1.3. CHANGE FORMAT SETTINGS



Scroll up and down to select function or settings.



Scroll up and down to select the format.

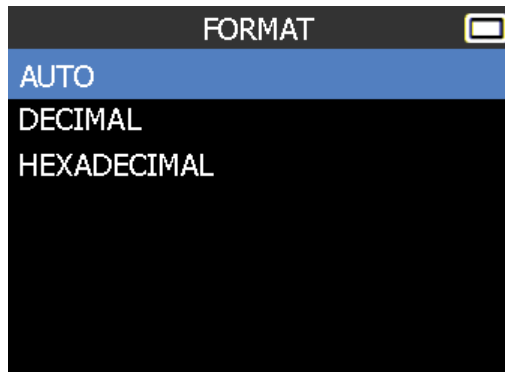
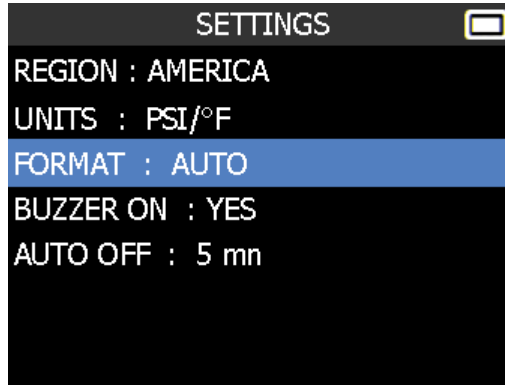

= continue



= Previous

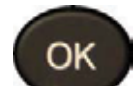

= continue



= Previous

**AUTO:** display sensor ID format in the way sensor is transmitting.

**DECIMAL:** force to display sensor ID in decimal (0 to 9).

**HEXADECIMAL:** force to display sensor ID in hexadecimal (0 to F).

### 1.4. CHANGE BUZZER ON SETTINGS

When buzzer on is set to **YES**, a beep is triggered when the sensor ID is detected.



Scroll up and down to select function or settings.

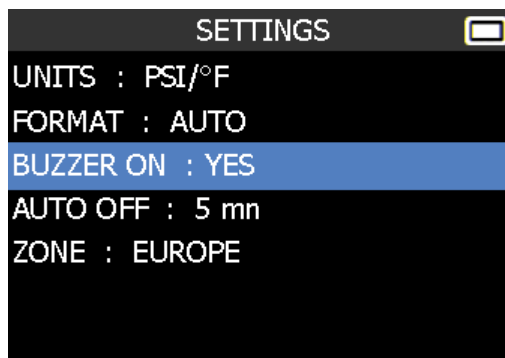

= continue



= Previous

## 1.5. CHANGE AUTO OFF SETTINGS



Scroll up and down to select function or settings.

The selection turns red.



Scroll up and down to set the time.

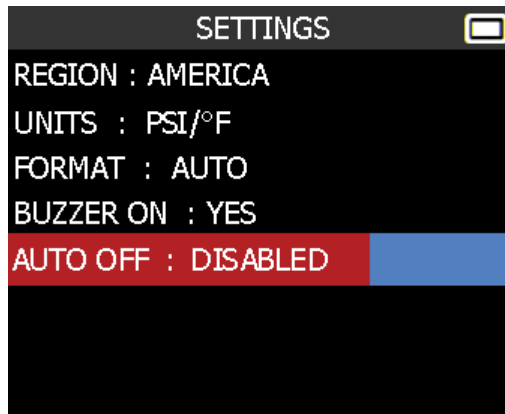
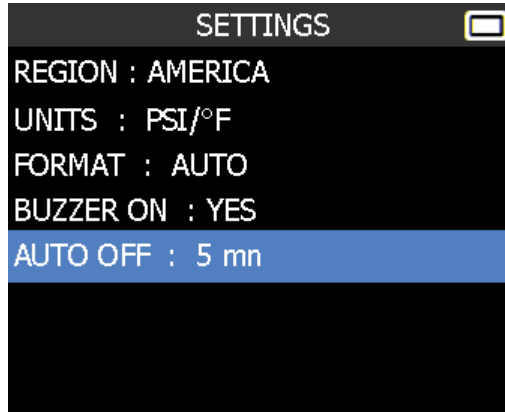

= continue



= Previous



= continue



= Previous

Change by **60 min** (maximum) to **DISABLED** (never).

---

## ABOUT

---

### 1. ENTER THE ABOUT MENU

This menu displays the current version and information about the device.



Select the "ABOUT" menu.

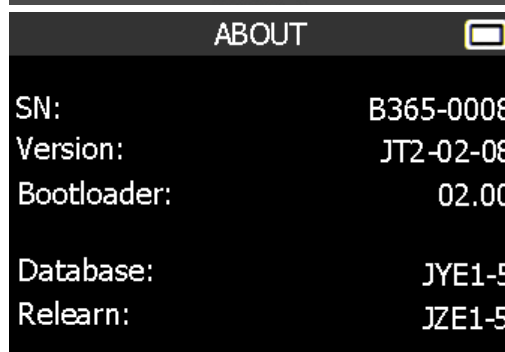

= continue



= Previous

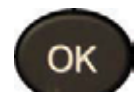

= Previous



= Previous

# LANGUAGE

## 1. ENTER LANGUAGE MENU



Select the "LANGUAGE" menu.



Scroll up and down to select the language.

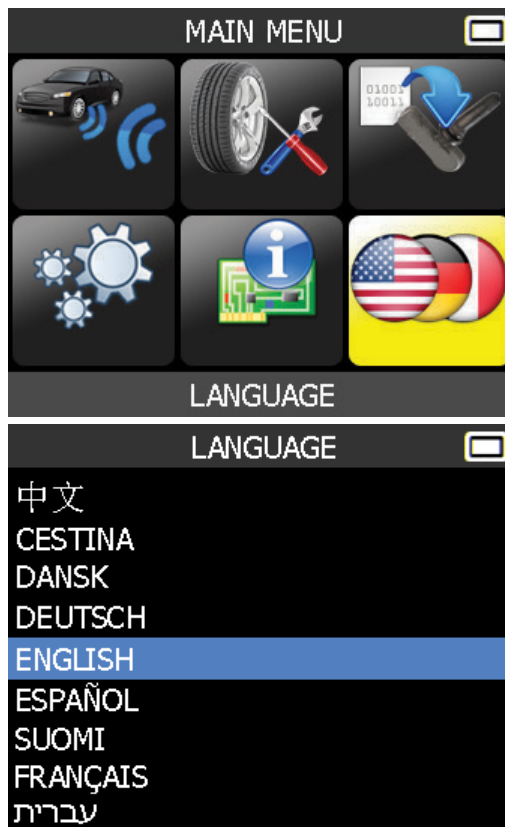

= continue



= Previous



= continue



= Previous

## Tool Update

### PLEASE FOLLOW THE 5 EASY STEPS:

1. Have device connected to PC via USB
2. Turn device "ON"
3. Launch WebVT  
(or install from [www.ateq-tpms.com/downloads](http://www.ateq-tpms.com/downloads))
4. Click on the "Renew" button
5. Enter subscription code if expiration date is highlighted in red.

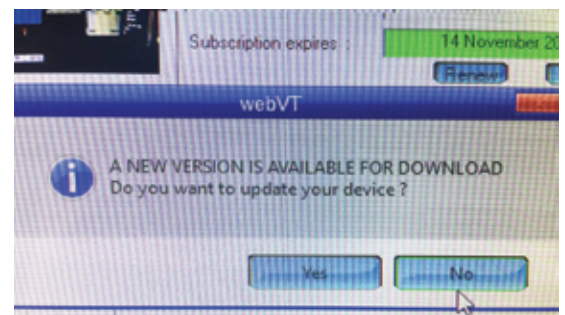

---

# MISCELLANEOUS

---

## 1. CHARGE

### Low Battery Indication

Your **TPMS TOOL** incorporates a low battery detection circuit. Battery life is an average of 300 sensor tests per battery charge (approximately 60 to 80 vehicles) this may change depending on the sensor model.

Battery indicator status:

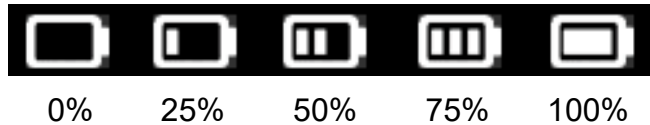

When 0% is flashing, the tool will turn off after 10 seconds.



The battery is charging.



There is an issue with the battery - please contact after sales service.

**DO NOT** use the tool with low battery status because the transmission and emission may not be reliable.

When charging, the battery light is red and becomes green when the battery is fully charged.



When the battery is low, the “status bar” appears every 10 seconds. This display will stop when the battery loses power.

Plug the USB cable between the tool and the charger adapter, and then plug the charger adapter into an appropriate outlet. The red LED "**CHARGE**" light will turn on.

### Battery replacement

The tool must be returned to the factory for battery replacement.

**Opening the tool or tampering with the seal placed on the tool, if broken, will void the warranty**



## 4. 1 YEAR LIMITED WARRANTY

The manufacturer warrants this product to the original user against defective material or workmanship for a period of 1 year from the date of purchase. The manufacturer reserves the right to determine whether the part or parts failed because of defective material, workmanship or other causes. Failures caused by accident, alteration, or misuse are not covered by this warranty. The manufacturer, at its discretion, will repair or replace product covered under this warranty free of charge.

Repairs or replacements of products covered under this warranty are warranted for the remainder of the original warranty period. The manufacturer or its authorized service representatives must perform all warranty repairs. Any repair to the product by unauthorized service representatives voids this warranty. The rights under this warranty are limited to the original user and may not be transferred to subsequent owners.

The warranty is in lieu of all other warranties, expressed or implied, including warranties of merchantability and fitness for a particular purpose. Some states do not allow the exclusion or limitations of incidental or consequential damages, so the above limitations may not apply to you.

### How to Obtain Warranty Support

Before submitting a warranty claim, we recommend you contact technical support for assistance by calling 1-888-621-8767. Valid warranty claims are generally processed through the point of purchase during the first thirty (30) days after purchase; however, this period of time may vary depending on where you purchased your product.

A Return Material Authorization (RMA) number will be issued by technical support based on the warranty claim requirements. Please check with Standard representative or the retailer where you purchased your product for details.

Warranty claims that cannot be processed through the point of purchase and any other product related questions should be addressed directly to ATEQ TPMS Tools LC. The address and customer service contact information for ATEQ can be found on the web at <https://www.ateq-tpms.com/en-us/home/contact-support/>

**Note:** Tools requiring service or warranty repair must be accompanied by an RMA number on the shipping container for proper handling.

### Limitation of Liability

STANDARD /MANUFACTURER SHALL NOT BE LIABLE FOR ANY SPECIAL INDIRECT,

INCIDENTAL OR CONSEQUENTIAL DAMAGES WHATSOEVER, INCLUDING BUT NOT LIMITED TO LOSS OF PROFITS, REVENUE OR DATA (WHETHER DIRECT OR INDIRECT) OR COMMERCIAL LOSS FOR BREACH OF ANY EXPRESS OR IMPLIED WARRANTY ON YOUR PRODUCT EVEN IF NAPA/ECHLIN TOOLS HAS BEEN ADVISED OF THE POSSIBILITY OF SUCH DAMAGES. Some jurisdictions do not allow the exclusion or limitation of special, indirect, incidental or consequential damages, so the above limitation or exclusion may not apply to you.

### Duration of Implied Warranties

EXCEPT TO THE EXTENT PROHIBITED BY APPLICABLE LAW, ANY IMPLIED WARRANTY OR CONDITION OF MERCHANTABILITY OR FITNESS ON THIS HARDWARE PRODUCT IS LIMITED IN DURATION TO THE DURATION OF THE APPLICABLE LIMITED WARRANTY PERIOD FOR YOUR PRODUCT. Some jurisdictions do not allow limitations on how long an implied warranty lasts, so the above limitation may not apply to you.

### National Statutory Rights

Consumers have legal rights under applicable national legislation governing the sale of consumer goods. Such rights are not affected by the warranties in this Limited Warranty.

### No Other Warranties

No Standard representative, agent or employee is authorized to make any modification, extension, or addition to this warranty.

---

# SERVICE

---

## 7. RECYCLING

**Do not dispose of the rechargeable Lithium-Ion battery or the tool and/or its accessories in the general waste.**



These components must be collected and recycled.



The crossed-out wheeled waste bin means that the product must be taken to separate collection at the end of the product's service life. This applies to your tool and also to any enhancements marked with this symbol. Do not dispose of these products as unsorted municipal waste. For further information, please contact **STANDARD**.

### Technical Support:

The ATEQ TPMS technical support hotline is available during normal business hours in English, French and Spanish. (North and South America only) When contacting Tech Support Helpdesk, be prepared to answer the following questions:

- What tool model is it? What is the tool's serial number?
  - Is the internal software up to date? Updating your tool solves the majority of issues.
  - If you are working on a vehicle, what car make, model and year are you servicing?
  - What sensors are you using? Please note the brand and reference of the sensors.
- 
- USA (En): 888-621-8767 (TPMS)
  - Latin/South America (Sp): Email Only: [tpms@atequsa.com](mailto:tpms@atequsa.com)
  - Canada (Fr): 855-455-8767 (TPMS)

### Hours of operation:

USA and Latin/South America: Monday through Friday, 8 am – 6 pm (EST)

Canada: Monday through Friday, 8 am – 6 pm (EST)

### Return Shipping Address:

**USA:** ATEQ TPMS Tools LC  
35990 Industrial Road  
Livonia, MI 48150

**Canada:** ATEQ Canada Inc.  
4-2355 Royal Windsor Drive  
Mississauga, ON L5J 4S8  
Canada

**Email address:** [tpms@atequsa.com](mailto:tpms@atequsa.com)

**Email Address:** [tpms@ateq.ca](mailto:tpms@ateq.ca)

# TECHSMART Parts List

## T46000



**OBDII Module  
w/cable (Optional)**  
P/N TPMSOBD2



**Battery**  
P/N T6250000

**Wall Charger**  
P/N T46000AC

**USB Cable**  
T46000USB  
(not pictured)

**Software Certificate**  
P/N TPMSSU

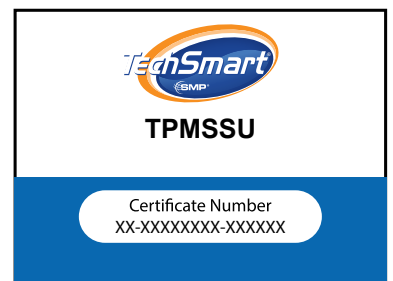

**Magnet (Optional)**  
P/N T6430000





**[TechSmartParts.com](http://TechSmartParts.com)**